

Embedded Solutions



microSD Cards

microSDXC460T

Utilizing top-quality 3D NAND Flash and rated to endure 3K P/E cycles, Transcend's microSDXC 460T memory cards combine the advantages of high performance and exceptional endurance at an affordable price. They are ideal for write-intensive applications such as medical devices, surveillance systems, and POS terminals.

Hardware Features

- Electrostatic protection (ESD IEC 61000-4-2)
- Compliant with Application Performance Class 2 (A2)
- Compliant with Video Speed Class 30 (V30)
- Endurance: 3K P/E cycles (Program/Erase cycles) guaranteed
- Compliant with SD specification 6.1

Ordering Information

64GB	TS64GUSD460T
128GB	TS128GUSD460T
256GB	TS256GUSD460T

Firmware Features

- Wear-Leveling
- Supports S.M.A.R.T. function to conduct health monitoring, analysis, and reporting for storage devices
- Early Move
- Built-in LDPC ECC (Error Correction Code) functionality

*Scope Pro is only available when used with the [RDF5](#) card reader.*Transcend's microSDXC 460T 64GB cards meet UHS-I Speed Class 1 (U1), Video Speed Class 10 (V10), and Application Performance Class 1 (A1) standards.

Specifications

Appearance	Dimensions	11 mm x 15 mm x 1 mm (0.43" x 0.59" x 0.04")
	Form Factor	microSD flash card
Storage	Flash Type	3D NAND flash
	Capacity	64 GB / 128 GB / 256 GB
Operating Environment	Operating Voltage	2.7V ~ 3.6V
	Drop Test	1.5m free fall
	Operating Temperature	Standard -25°C (-13°F) ~ 85°C (185°F)
	Storage Temperature	-40°C (-40°F) ~ 85°C (185°F)
	Humidity	0% ~ 95%
	Shock	Acceleration: 490 m/s ² (standard holding time: 11 ms, semi-sine wave, velocity change: 3.44 m/s)
	Vibration (Operating)	20 G (peak-to-peak), 20 Hz ~ 2,000 Hz (frequency)
Power	Power Consumption (Max.)	0.5 watt(s)
Performance	Read Speed (Max.)	up to 100 MB/s
	Write Speed (Max.)	up to 80 MB/s
	Terabytes Written (TBW)	up to 663 TBW
Warranty	Certificate	CE / FCC
	Warranty	Three-year Limited Warranty

Mechanical Dimensions

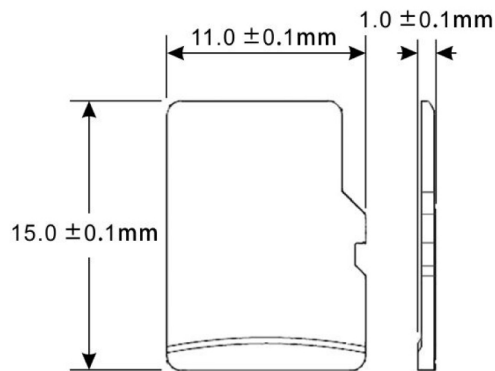

Product specifications are subject to change without notice. Pictures shown may differ from actual products. Total accessible capacity varies depending on operating environment. Due to the complexity and variety of industrial applications, Transcend cannot guarantee 100% compatibility with all platforms and under all scenarios. For special applications and environments, it is strongly suggested that you contact Transcend beforehand for clarification.